

**KONKA 康佳**

■ KONKA R&D BUILDING



**LED 商业显示**  
LED DISPLAY

**KONKA 康佳**

# CONTENTS

## 目录

---

1	高清小间距系列		
	HD Series		
	AH系列 AH Series	5	
	AF系列 AF Series	7	

A系列 A Series	9	
--------------	---	--

2	租赁系列		
	Rental Series		
	RE系列 RE Series	13	
	RI系列 RI Series	15	

RO系列 RO Series	17	
----------------	----	--

3	光栅系列		
	Mesh Series		
	C系列 C Series	21	

4	固定安装系列		
	Fixed Installation Series		
	S系列 S Series	25	
	G系列 G Series	27	
	P系列 P Series	29	

5	定制产品		
	Customization		
	T系列 T Series	33	

D系列 D Series	35	
--------------	----	--

---



# 高清小间距系列

HD series

---

AF系列 AF Series

AH系列 AH Series

A系列 A Series

## 深圳市人民医院

The People's Hospital

## 华侨城展厅

The OCT Exhibition Hall

## 深圳广播电视台

Shenzhen TV Station



# 案例展示

# REFERENCE

# AH系列 高端场景专用产品

AH series High end scenes dedicat



## 应用范围:

广电演播厅、安防监控中心、公安指挥中心、军事指挥中心

## Application areas:

Radio and television studio、Security monitor center、Public security command center、Military command center

## 产品细节 Product details



独立液晶监控显示屏  
Separate LCD display

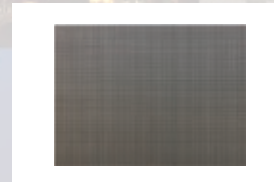

模组正面  
Front



模组背面  
Back



箱体结构  
Cabinet structure

## 产品特点 Features

- ◆ 双路信号输入，自动检测信号的完整性,双电源供电，保证显示屏正常工作  
Redundant power supply design,dual signal inputs,automatically detecting the failure then switch,ensure the whole system's stability and reliability.
- ◆ 液晶面板单元监控系统，方便只管检测单个箱体的运行指数  
By using advanced LCD monitoring system,clearly showing voltage.
- ◆ 低亮高灰，画面更完美  
Low brightness with high gray scale
- ◆ 专利面罩设计，获得更好的对比度和达到消除摩尔纹的效果  
Patented mask technology can reach a perfect contrast ratio and eliminate the moire effect.
- ◆ 高达3840Hz的高刷新率保持高品质的显示性能  
Up to 3840Hz high refresh rate keeps it high quality display.
- ◆ 完美弧度流畅显现，提供一个更广阔的视角  
Small size which is more flexible for curve display, to provide a broader viewing angle.



无缝拼接  
seamless  
splicing



高散热  
Optimized  
cooling



平整度好  
Good flatness



低温升  
slow temp  
rise



寿命长  
long lifetime



无风扇  
fanless



无噪音  
quiet



故障率低  
low failure rate



使用安全  
safety

## 产品参数 Specifications

型号 mode	AH1.2	AH1.5	AH1.6	AH1.9	AH2.5
像素间距 Pixel pitch(mm)	1.25mm	1.56mm	1.66mm	1.92mm	2.5mm
像素密度 Pixel density(px/m <sup>2</sup> )	640,000	409,600	360,000	270,400	160,000
箱体分辨率 Cabinet resolution	320×240	256×192	240×180	208×156	160×120
面罩 Mask	选配 Optional	选配 Optional	选配 Optional	选配 Optional	选配 Optional
箱体尺寸 Cabinet size(mm)	400×300×100				
单点校正 Pixels calibration	标配色度和亮度校正功能 Standard color and brightness calibration				
白平衡亮度 Brightness	100cd~1500cd/ m <sup>2</sup>				
色温 color temperature	2500K~10000K				
控制系统 control system	双系统 Dual signal card				
液晶单元监控 LCD monitor	温度、湿度、电源、工作状态监控显示 Temperature, humidity, voltage and working hours				
驱动方式 Drive mode	恒流驱动 Constant current				
换帧频率 Frame frequency(Hz)	50/60Hz, 120Hz				
刷新率 Refresh rate	普刷 Standard refresh: ≤1920Hz, 高刷新 High refresh: ≤3840Hz				
供电要求 Working voltage	AC: 85V~264V, 50~60Hz ( 双备份电源 power dual backup )				
工作温度范围 Operating temperature	-20° C~+50° C				
存储温度范围 Storage temperature	-25° C~+60° C				
工作湿度范围 humidity range	10%~90%，无凝结 Non-condensing				
箱体重量 Weight (kg)	4.2kg				

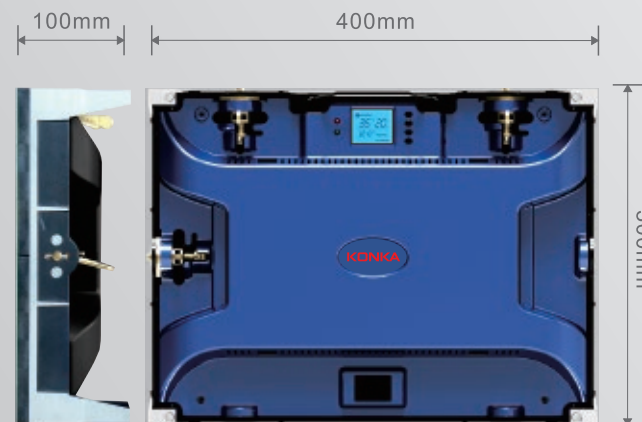

# AF系列 高端前维护产品

AF series high-end front maintenance



## 应用范围:

高端会议室、展览展示中心、  
政府礼堂、酒店宴会厅

## Application areas:

High-end conference room,  
exhibition center, Government  
hall, hotel banquet hall



## 产品细节 Product details



完全前维护  
Completely front  
maintenance

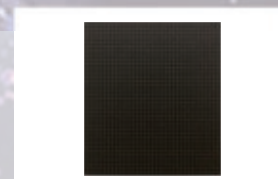

模组正面  
Front

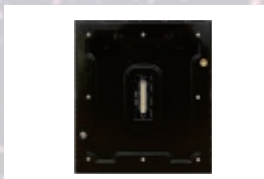

模组背面  
Back

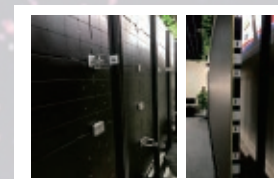

全封闭箱体结构  
Totally enclosed design



## 产品特点 Features

- ◆ 16:9黄金比例，可点对点轻易拼接成720px, 1080px, 3840px 等标准分辨率大屏，16:9 golden ratio, ensure the best display effect, showing video pixel by pixel, includes 720p, 1080p and 4K pixels.
- ◆ 箱体和模组分离式结构，模组与模组之间均采用无线连接。Cabinets and modules are separated packed; Cabinets and modules are wireless connected.
- ◆ 双路信号输入，自动检测信号的完整性,双电源供电，保证显示屏正常工作 Redundant power supply design, dual signal inputs, automatically detecting the failure then switch, ensure the whole system's stability and reliability.
- ◆ 采用全封闭式箱体结构，可以起到背面防水、防尘的作用，防止空气杂质进入到箱体内部；保证复杂条件下防护标准，提高产品的使用寿命。With totally enclosed design at the back, which helps prevent dust, water, and air-impurity getting in, extend product's life even in complicated environment.
- ◆ 专用配件可实现58mm厚的吊装和最薄60mm贴墙安装，实用完全前维护。Extremely saving rooms by using customized fittings, can reach a depth of 58 mm by hanging or 60 mm by wall mounting.
- ◆ 无线安装，硬连接，热插拔，箱体拼接采用内部硬连接，拼接大屏0连接线，用户级安装。Wireless connection between modules and cabinets, hot-plug supported, easy and friendly installation & maintenance experience.



无缝拼接  
seamless  
splicing



高散热  
Optimized  
cooling



平整度好  
Good flatness



低温升  
slow temp  
rise



寿命长  
long lifetime



无风扇  
fanless



无噪音  
quiet



故障率低  
low failure rate



使用安全  
safety

## 产品参数 Specifications

型号 mode	AF1.0	AF1.2	AF1.3	AF1.4	AF1.5	AF1.8	AF2.0
像素间距 Pixel pitch(mm)	1.0mm	1.25mm	1.33mm	1.45mm	1.55mm	1.87mm	2.0mm
像素密度 Pixel density(px/m <sup>2</sup> )	1,000,000	640,000	562,500	473,600	406,820	283,350	250,000
箱体分辨率 Cabinet resolution	640×360	512×288	480×270	440×248	404×232	340×192	320×180
面罩 Mask	选配 Optional	选配 Optional	选配 Optional	选配 Optional	选配 Optional	选配 Optional	选配 Optional
箱体尺寸 Cabinet size(mm)	640×360×58						
白平衡亮度 Brightness	100cd~1200cd/ m <sup>2</sup>						
色温 color temperature	2000K~9500K						
驱动方式 Drive mode	恒流驱动 Constant current						
换帧频率 Frame frequency(Hz)	50/60Hz, 120Hz						
刷新率 Refresh rate	普刷 Standard refresh: ≤1920Hz, 高刷新 High refresh: ≤3840Hz						
供电要求 Working voltage	AC: 105V~240V, 50~60Hz						
寿命 Lifetime (hours)	100,000						
工作温度范围 Operating temperature	-10° C~+60° C						
存储温度范围 Storage temperature	-25° C~+60° C						
工作湿度范围 humidity range	10%~90%，无凝结 Non-condensing						
箱体重量 Weight (kg)	7.4kg						

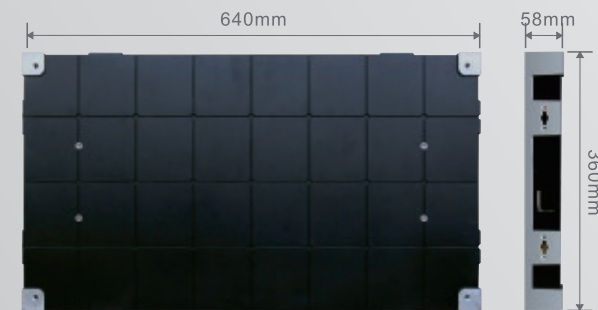

# A系列 高性价比产品

A series Cost-effective products



## 应用范围:

展览展示中心、企业展厅、  
酒店宴会厅、会议室

## Application areas:

Exhibition center, exhibition hall,  
Hotel banquet hall, meeting room



## 产品细节 Product details

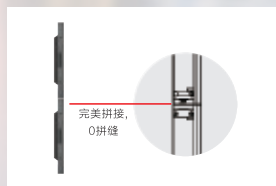

完美拼接,  
0拼缝

高平整度  
Great Flatness



模块正面  
Front



模块背面  
Back



CNC铝基板散热更快  
Fast heat dissipation

## 产品特点 Features

- ◆ 采用高品质LED灯珠和PWM的高阶恒流源，使显示画面显色性、色彩还原度和低灰细节表现更突出。在100cd/m<sup>2</sup>时也具备高灰阶的优异表现。  
use high quality LED Lamps and PWM drive IC, excellent gray scale performance even in low-brightness of 100 cd/m<sup>2</sup>.
- ◆ 专利的面罩设计，获得更好的对比度和达到消除摩尔纹的效果。  
patented mask technology can reach a perfect contrast ratio and eliminate the moire effect.
- ◆ 恒流源IC和电源与铝基板贴合散热的方式，确保更高效的散热效果。  
Drive IC and power supply stick to the aluminum base plate, CNC aluminum base plate is a big heat-sink itself, with the vent at the back also to ensure the best cooling effect.
- ◆ 采用CNC精加工铝基板，冷板加工不存在热失效变形，确保了最高的平整度。  
Fine aluminum base board which is cold processing ensure the best flatness.



无缝拼接  
seamless  
splicing



高散热  
Optimized  
cooling



平整度好  
Good flatness



低温升  
slow temp  
rise



寿命长  
long lifetime



无风扇  
fanless



无噪音  
quiet



故障率低  
low failure rate



使用安全  
safety

## 产品参数 Specifications

型号 model	A1.6	A1.8	A2.0	A2.5
像素间距 Pixel pitch(mm)	1.66mm	1.87mm	2.0mm	2.5mm
像素密度 Pixel density(px/m <sup>2</sup> )	360,000	284,445	250,000	160,000
箱体分辨率 Cabinet resolution	288×288	256×256	240×240	192×192
面罩 Mask	选配 Optional	选配 Optional	选配 Optional	选配 Optional
箱体尺寸 Cabinet size(mm)	480mm×480mm×60mm			
白平衡亮度 Brightness	100cd~1500cd/ m			
色温 color temperature	2500K~10000K			
驱动方式 Drive mode	恒流驱动 Constant current			
换帧频率 Frame frequency(Hz)	50/60Hz, 120Hz			
刷新率 Refresh rate	普刷 Standard refresh: ≤1920Hz, 高刷新 High refresh: ≤3840Hz			
供电要求 Working voltage	AC: 85V~264V, 50~60Hz			
功耗 Power consumption	135W			
寿命 Lifetime (hours)	100,000			
工作温度范围 Operating temperature	-20° C~+50° C			
存储温度范围 Storage temperature	-25° C~+60° C			
工作湿度范围 humidity range	10%~90%, 无凝结 Non-condensing			
箱体重量 Weight (kg)	6.0kg			

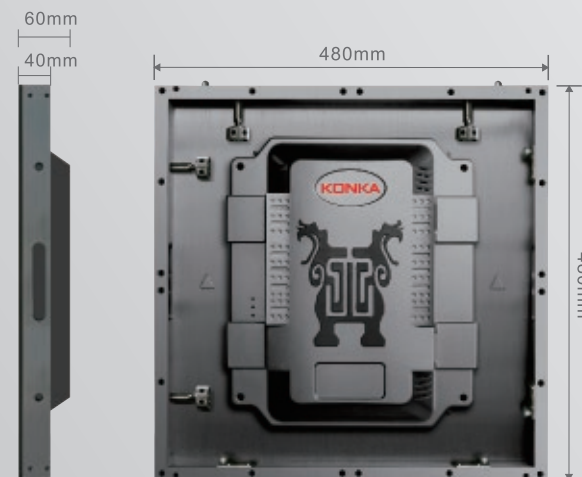



# 租赁系列

Rental series

---

RI 系列 RI Series

RO系列 RO Series

RE系列 RE Series



THE STAR舞台屏  
The Star Stage Screen



雷克萨斯展会  
Lexus Exhibition



土耳其（政府项目）  
Govement Project, Turkey



案例展示

REFERENCE



# RI系列 户内租赁产品

RI series indoor rental products



## 应用范围:

大型全天候户内外综合娱乐广场、影院剧院、演艺背景屏、展会展示等应用领域

## Application areas:

indoor and outdoor use, large scale squares, theaters, events, trade shows and so forth.

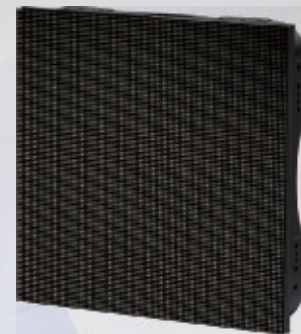

## 产品细节 Product details

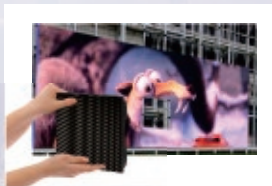

整屏任意拆出  
any module can be dismantled independently



独特散热凹槽结构  
groove design increase heat dissipation



防水航空头  
water proof air plug



快速安装边锁  
Locking system

## 产品特点 Features

- ◆ 薄: 最厚处不超过8cm; 轻: 每个箱体8.8kg;  
Ultra thin(the thickness part is less than 8cm),lightweight(8.8kg/tile)
- ◆ 采用SMD黑灯, 可视角大, 高对比度(5000:1), 图像柔和;  
Black SMD,large viewing angle,high contrast ratio (5000:1),superior performance.
- ◆ 铸铝结构, 双边框设计, 高精度无缝拼接;  
Die-casting aluminum structre, seamless splicing.
- ◆ 箱体与箱体之间通过特殊的卡扣结构连接, 不需要借助其他工具;  
Can assemble the LED screens without tools due to the integrating locking mechanism
- ◆ 500×500标准箱体, 快速计算面积, 方便搬运及快速拼屏;  
Cabinet size: 500×500cm.
- ◆ 快插式连线设计  
Fast connector



无缝拼接  
seamless  
splicing



轻便  
light



维护简单  
easy to maintain



SMD黑灯  
black SMD



广视域  
viewing angle



超薄  
light



租赁/固装  
rental / fixed

## 产品参数 Specifications

型号 mode	RI2	RI3	RI5	RI6
像素间距 Pixel pitch (mm)	2.9	3.9	5.2	6.25
箱体尺寸 Cabinet size (mm)	500×500×75	500×500×75	500×500×75	500×500×75
箱体分辨率(px)	168×168	128×128	96×96	80×80
箱体重量 Cabinet weight (kg)	8.5	8.5	8.5	8.5
LED封装形式 LED configuration	SMD2121	SMD2121	SMD3528	SMD3528
亮度 Brightness			1500cd/ m <sup>2</sup>	
屏体色温 Screen color temperature			2000K~9500K	
水平/垂视角 Viewing angle (H/V)			140° /140°	
驱动方式 Drive mode			恒流驱动	
刷新率 Refresh rate			≥ 1200Hz	
工作电压 Operating voltage			AC: 105V~240V, 50~60Hz	
平均功率 Average power			200W/m <sup>2</sup>	
最大功率 Maximum power			600W/m <sup>2</sup>	
防护等级 Protection class			IP41	
工作温度范围 Operating temperature			-10° C~+50° C	
工作湿度范围 Working humidity			10%~90%RH	



# RO系列 户外租赁产品

RO series outdoor rental products



## 应用范围:

大型全天候户内外综合娱乐广场、影院剧院、演艺背景屏、展会展示等应用领域。

## Application areas:

indoor and outdoor use, large scale squares, theaters, events, trade shows and so forth.

## 产品细节 Product details



三合一表贴户外防水灯  
Outdoor 3-in-1 SMD



快速安装锁  
Locking system



全防水模块  
Full waterproof mode

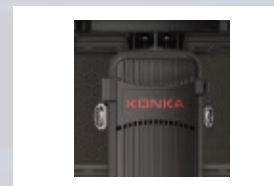

背面散热设计  
Back ventilation design



## 产品特点 Features

- ◆ 优质显示：高分辨率高灰高密高对比度，使用寿命长  
Premium image performance, reliable and durable
- ◆ 高精工艺设计：高平整无缝拼接箱体，无风扇静音；单个箱体11KG，最厚处仅为80mm，降低运输成本；  
Even and noise free, light (11KG/tile) and thin (up to 8 cm), save transport cost and install cost
- ◆ 弧形拼接：边锁可调节角度，实现弧形拼接；  
Convex or concave curved walls with various angles can be created by adjusting the lock angle
- ◆ 简易维护：箱体连接采用快速连接结构，装卸无需工具；整屏任意位置可单独拆卸；  
Easy to setup and maintain allows for the assembly of LED screens without tools.
- ◆ 适用性强：满足吊装、堆装、固定安装需求，户内外多种点间距兼容；  
Applicable to rental, fixed install, in- and outdoor use.



静音设计  
noise free



高对比度  
high contrast



弧形拼接  
curved install



高通透  
transparency



租赁/固定  
rental / fixed



超薄  
light



## 产品参数 Specifications

型号 mode	R03	R04	R05	R06
像素间距 Pixel pitch (mm)	3.9	4.8	5.2	6.25
箱体尺寸 Cabinet size (mm)	500×500×75	500×500×75	500×500×75	500×500×75
箱体分辨率(px)	128×128	104×104	96×96	40×40
箱体重量 Cabinet weight (kg)	9.5	9.5	9.5	9.5
LED封装形式 LED configuration	SMD1921	SMD1921	SMD2727	SMD3535
亮度 Brightness	5000cd/㎡	5000cd/㎡	5000cd/㎡	6000cd/㎡
刷新率 Refresh rate	≥1200Hz	≥1200Hz	≥1200Hz	≥1920Hz
平均功率 Average power	200W/㎡	200W/㎡	200W/㎡	250W/㎡
最大功率 Maximum power	600W/㎡	600W/㎡	600W/㎡	800W/㎡
屏体色温 Screen color temperature	2000K-9500K	2000K-9500K	2000K-9500K	2000K-9500K
水平/垂直视角 Viewing angle (H/V)	140° /140°	140° /140°	140° /140°	140° /140°
驱动方式 Drive mode	恒流驱动	恒流驱动	恒流驱动	恒流驱动
工作电压 Operating voltage	AC: 105V~240V, 50~60Hz	AC: 105V~240V, 50~60Hz	AC: 105V~240V, 50~60Hz	AC: 105V~240V, 50~60Hz
防护等级 Protection class	IP65/IP54	IP65/IP54	IP65/IP54	IP65/IP54
工作温度范围 Operating temperature	-10° C~+50° C	-10° C~+50° C	-10° C~+50° C	-10° C~+50° C
工作湿度范围 Working humidity	10%~90%RH	10%~90%RH	10%~90%RH	10%~90%RH

# RE系列 租赁固定安装两用产品

RE series  
rental and fixed installation products



## 应用范围:

多元综合应用于商业地产、购物中心、大型广场、广告屏、交通屏等领域。

## Application areas:

Buildings, shopping malls, large-scale squares, outdoor advertisements, traffic and so on.



## 产品细节 Product details



电源信号双备份  
Power and signal loop  
dual backup



完全压铸铝箱体  
Full die cast aluminum  
case



电源及信号状态自检指示灯  
Power and signal indicator  
light



快速安装边锁  
Locking system

## 产品特点 Features

- ◆ 轻: 箱体尺寸480mm×480mm, 重量仅为8.5kg;  
lightweight: cabinet size 480mm×480mm,cabinet weight 8.5kg;
- ◆ 快: 箱体连接采用快速连接机构, 装卸无需工具;  
easy install: fully integrated locking mechanism allows for the assembly of LED screens without tools.
- ◆ 易: 整屏任意位置可单独安装拆卸箱体, 现场维护简单;  
easy dismantle: any cabinet in the whole screen can be easily dismantled
- ◆ 稳: 经过高温40度、低温零下20度白屏老化测试, 依然正常工作;  
stable: can work at -20℃ to 40℃.
- ◆ 高刷新、高灰阶、高对比, 优质精细的画面效果;  
high refresh rate, high gray scale, high contrast ratio,superior performance.
- ◆ 薄: 箱体最薄处仅为25mm, 最厚处仅为75mm;  
the thinnest part is 25mm and thickest part is 75mm.
- ◆ 精: 压铸铝成型工艺, 箱体公差控制在0.1mm以内, 整屏平整度和拼接缝隙小于0.5mm;  
Seamless installation:cabinet tolerance is less than 0.1mm,and the gap between cabinets is than 0.5mm.
- ◆ 容: 满足吊装、堆装、固定安装需求, 户内外多种点间距兼容;  
Applicable to rental,floor mounted and fixed installation.
- ◆ 低: 箱体功耗低、噪音低、运输成本低、安装费用低。  
Low power consumption,low noise ,low transport cost ,low installation cost.



轻便  
light



超薄  
light



维护简单  
easy to maintain



租赁/固装  
rental/ fixed



可靠稳定  
reliable



四“低”  
4 "lows"



无缝拼接  
seamless  
splicing



画质精细  
superior  
performance



高亮度  
bright

## 产品参数 Specifications

型号 mode	RE2.5	RE3.0
像素间距 Pixel pitch	2.5mm	3.0mm
像素密度 Pixel density (Px/m <sup>2</sup> )	160,000	111,111
箱体尺寸 Cabinet size (mm)	480mm×480mm×80mm	576mm×576mm×80mm
箱体分辨率(px)	192×192	192×192
箱体重量 Cabinet weight (kg)	7.0kg	9.5kg
LED封装形式 LED configuration	SMD2020	SMD2020
亮度 Brightness	800cd/ m <sup>2</sup>	800cd/ m <sup>2</sup>
屏色色温 Screen color temperature	2000K~9500K可调	2000K~9500K可调
水平/垂直视角 Viewing angle (H/V)	160° /140°	160° /140°
驱动方式 Drive mode	恒流驱动	恒流驱动
刷新率 Refresh rate	≥1200Hz	≥1200Hz
工作电压 Operating voltage	AC: 105V~245V, 50~60Hz	AC: 105V~245V, 50~60Hz
最大功率 Maximum power	≤800W	≤800W
平均功率 Average power	100,000	100,000
防护等级 Protection class	IP41	IP41
工作温度范围 Operating temperature	-20° C~+40° C	-20° C~+40° C
工作湿度范围 Working humidity	10%~90%, 无凝结	10%~90%, 无凝结

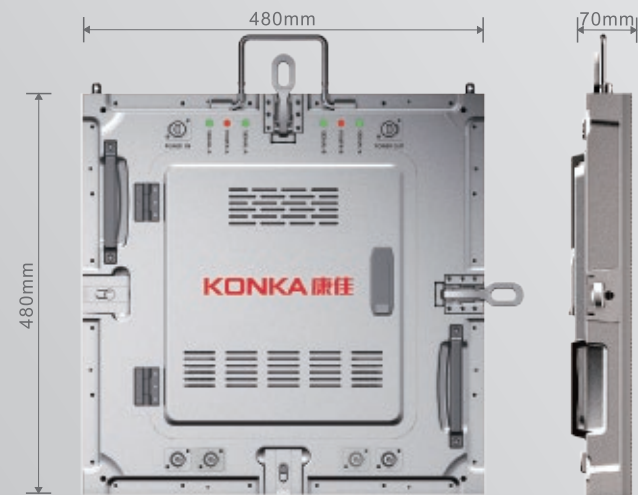



光栅系列  
Mesh series

C系列 C Series

河北石家庄  
广播电视塔项目  
Hebei TV Tower



北京盘古大观  
Beijing Pangu Building



东部华侨城天幕  
Heaven Street, Shenzhen Eastern OCT



# 案例展示

## REFERENCE



# C系列 C series



## 应用范围:

大型全天候户内外综合娱乐广场、影院剧院、演艺背景屏、展会展示等应用领域。

## Application areas:

indoor and outdoor use, large scale squares, theaters, events, trade shows and so forth.



## 产品细节 Product details

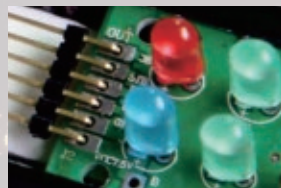

高可靠连接排针  
Pins

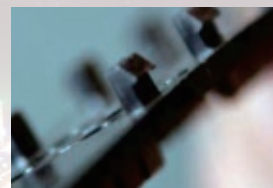

无螺丝紧固灯条  
no screws installation



双层防水箱体  
two layers water proof



屏体外部无线化安装  
no cables

## 产品特点 Features

- ◆ 超轻:每平方米最轻重量仅13kg  
Ultra-Light: 13kg/m<sup>2</sup>
- ◆ 高透率: 最高达68%  
High permeability: Up to 68%
- ◆ 极高的防护等级: 采用特殊的二次灌胶工艺, 在PCBA的上下两面均用电子灌胶将电路部分完全覆盖住, 使产品完全达到IP65的防护等级  
High IP rating(IP65)
- ◆ 双层防水箱体: 控制与电源箱采用双层防水结构, 确保电源与控制及所有连接线的安全;  
Waterproof: two-layer waterproof structure for controller and power box ensures safe connection.
- ◆ 屏体外部无线化安装, 便捷、美观;  
Clean install: no extra cables outside the cabinets.



高亮度  
bright



弧形拼接  
curved install



租赁/固装  
rental / fixed



高通透  
transparency



超薄  
light

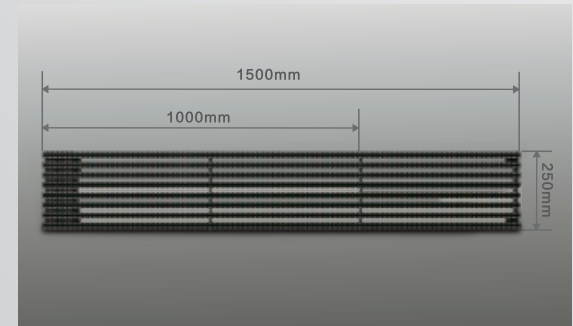
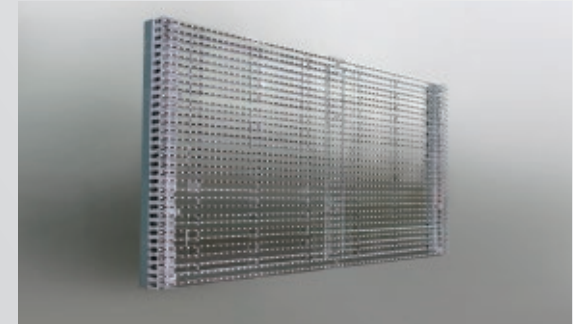

## 产品参数 Specifications

型号 mode	C5	C6	C8	C10	C15	C20	C31
应用场景 Application	户内 indoor	户内 indoor	户内 indoor	户内 indoor	户外 Outdoor	户外 Outdoor	户外 Outdoor
像素间距 Pixel pitch (mm)	5.2	6.25	8.93	10.41	15.625	20	31.25
箱体尺寸 Cabinet size (mm)	500×1000×80	500×1000×80	500×1000×80	1000×1000×80	1500×250×90 / 1000×250×90	1500×250×90 / 1000×250×90	1500×250×90 / 1000×250×90
箱体分辨率 (px) Cabinet resolution	96×192	80×160	56×112	96×96	64×64	75×16 / 50×16	48×8 / 32×8
亮度 Brightness	≥5000 cd/m <sup>2</sup>	≥5000 cd/m <sup>2</sup>	≥4200 cd/m <sup>2</sup>	≥4200 cd/m <sup>2</sup>	≥4200 cd/m <sup>2</sup>	6500 cd/m <sup>2</sup>	6500 cd/m <sup>2</sup>
平均功率 Average power	340W/ m <sup>2</sup>	280W/ m <sup>2</sup>	212W/ m <sup>2</sup>	320W/ m <sup>2</sup>	200W/ m <sup>2</sup>	150W/ m <sup>2</sup>	100W/ m <sup>2</sup>
最大功率 Maximum power	850W/ m <sup>2</sup>	700W/ m <sup>2</sup>	530W/ m <sup>2</sup>	800W/ m <sup>2</sup>	550W/ m <sup>2</sup>	400W/ m <sup>2</sup>	280W/ m <sup>2</sup>
刷新率 Refresh rate		16bit ≥2880; 14bit ≥4800; 10bit ≥9600			1920Hz	1920Hz	3840Hz
水平/垂直视角 Viewing angle (H/V)			140° /140°			120° /60°	
驱动方式 Drive mode			恒流驱动			恒流驱动	
工作电压 Operating voltage		AC:105V~240V,50~60Hz				AC:105V~240V,50~60Hz	
防护等级 Protection class		IP30				IP68	
工作温度范围 Operating temperature		-10° C~+40° C				-40° C~+60° C	
工作湿度范围 Working humidity		10%~90%, 无凝结				10%~90%, 无凝结	



# 固定安装系列

---

Fixed installation series

S系列 S Series

G系列 G Series

P系列 P Series



## 中国 深圳世界之窗

Window Of The World ,China



## 西南交通大学 国际会议厅

SouthWest JiaoTong University  
International Conference Hall



## 十二届全运会 沈阳市政府广场灯柱

The twelve National Games  
The government square lampstandard, shenyang



# 案例展示

# REFERENCE

# S系列 户内表贴产品

S series indoor SMD products



## 应用范围:

商业地产、购物中心、大型广场、高档酒店宴会厅、演播厅、酒吧舞台、剧院、学校、会议室等领域。

## Application areas:

Commercial real estate ,shopping mall,large-scale squares,hotel ballrooms,studio, pubs,stages,theaters,schools,conference rooms and etc.

## 产品细节 Product details



箱体后门锁方向提示  
Lock



户内表贴LED  
Indoor 3-in-1 SMD



内置式箱体把手  
Handle

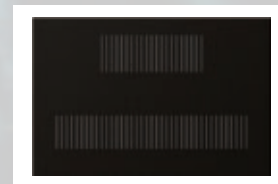

散热通道  
Heat dissipation

## 产品特点 Features

- ◆ 色彩丰富：高饱和度、高解析度、高刷新的显示特点，满足高频率动态图像播放需求；  
Brilliant colors: high saturation, high resolution, high refresh rate
- ◆ 优异显示：采用逐点校正技术，图像更清晰、层次感更强；  
Superior performance: nonlinear calibration ensures clearer image
- ◆ 可靠稳定：采用扫描技术和模块化设计技术，可靠性、稳定性更高；  
Reliable and stable: adopt distributed scan mode technology and modular design technology
- ◆ 显示模式多样化：支持多种显示模式；  
Diverse display mode
- ◆ 操作方便：采用通用视频播放软件，使系统操作十分方便。  
Easy operation: adopt universal video players



色彩丰富  
brilliant color



优异显示  
superior performance



可靠稳定  
reliable and stable



显示模式多样  
diverse display mode



可靠稳定  
reliable

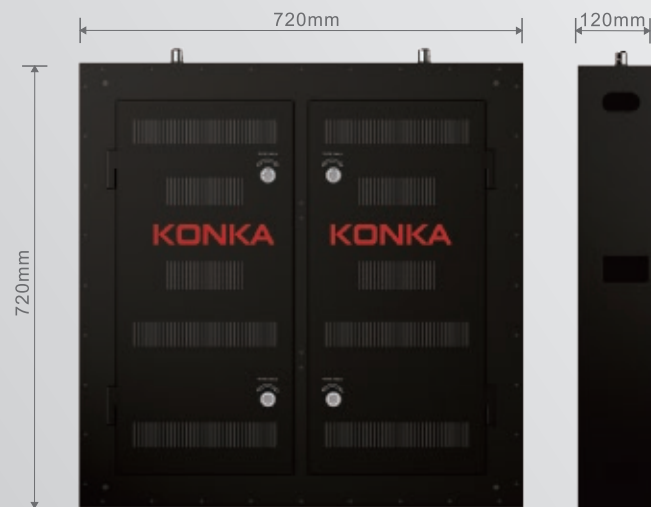

## 产品参数 Specifications

型号model	S3	S4	S5	S6
像素间距 Pixel pitch (mm)	3	4	5	6
箱体尺寸 Cabinet size (mm)	768×576×120	768×576×120	960×960×120	1152×1152×120
箱体分辨率(px)	256×192	256×128	192×192	192×192
LED封装形式 LED configuration	SMD2020	SMD2020	SMD3528	SMD3528
亮度 Brightness	800cd/ m <sup>2</sup>	800cd/ m <sup>2</sup>	1000cd/ m <sup>2</sup>	1000cd/ m <sup>2</sup>
刷新率 Refresh rate	≥ 1200Hz	≥ 1200Hz	≥ 1200Hz	≥ 1200Hz
平均功率 Average power	200W/m <sup>2</sup>	200W/m <sup>2</sup>	200W/m <sup>2</sup>	200W/m <sup>2</sup>
最大功率 Maximum power	600W/m <sup>2</sup>	600W/m <sup>2</sup>	600W/m <sup>2</sup>	600W/m <sup>2</sup>
屏体色温 Screen color temperature	2000K~9500K	2000K~9500K	2000K~9500K	2000K~9500K
水平/垂直视角 Viewing angle (H/V)	120° /120°	120° /120°	120° /120°	120° /120°
驱动方式 Drive mode	恒流驱动	恒流驱动	恒流驱动	恒流驱动
工作电压 Operating voltage	AC: 105V~240V, 50~60Hz	AC: 105V~240V, 50~60Hz	AC: 105V~240V, 50~60Hz	AC: 105V~240V, 50~60Hz
防护等级 Protection class	IP41	IP41	IP41	IP41
工作温度范围 Operating temperature	-10° C~+50° C	-10° C~+50° C	-10° C~+50° C	-10° C~+50° C
工作湿度范围 Working humidity	10%~90%RH	10%~90%RH	10%~90%RH	10%~90%RH

# G系列 户外表贴产品

G series outdoor SMD products



## 应用范围:

大型全天候户内外综合娱乐广场、影院剧院、演艺背景屏、展会展示等应用领域。

## Application areas:

indoor and outdoor use, large scale squares, theaters, events, trade shows and so forth.

## 产品细节 Product details

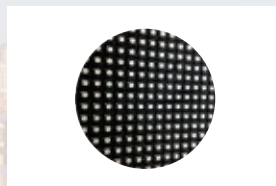

模块正面  
front

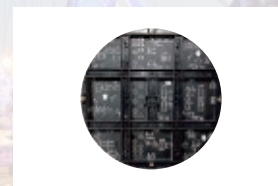

模块背面  
back

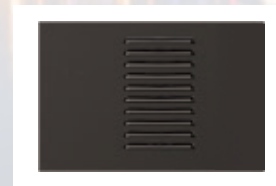

散热通道  
heat dissipation



防水信号航插头  
water proof signal air plug

## 产品特点 Features

- ◆ 高亮真彩,性能稳定:丰富色彩绚丽逼真,高饱和度、高解析度、高频率动态图像,完美呈现,精挑细选原材料、严谨的制造工艺,保证稳定可靠;  
High brightness,full color,stable: high saturation,high resolution,high refresh rate
- ◆ 适用性强:专业针对户外环境条件研究设计,箱体IP65/IP43高防护等级,适用于各种恶劣环境;  
Applicable to all weather: IP65/IP43
- ◆ 广视域:宽视角设计,画面效果更优质,受众人群更广。  
Wide viewing angle



高亮真彩  
high brightness and full color



广视域  
viewing angle



节能  
energy efficient



## 产品参数 Specifications

型号 mode	G4	G5	G6	G8	G10
像素间距 Pixel pitch (mm)	4	5	6	8	10
箱体尺寸 Cabinet size (mm)	768×768×145	768×768×145	768×1152×145	1024×1024×145	960×960×145
箱体分辨率(px)	256×128	256×128	128×192	128×128	96×96
LED封装形式 LED configuration	SMD1921	SMD2727	SMD3535	SMD3535	SMD3535
亮度 Brightness	500cd/ m <sup>2</sup>	5000cd/ m <sup>2</sup>	5500cd/ m <sup>2</sup>	6000cd/ m <sup>2</sup>	6500cd/ m <sup>2</sup>
刷新率 Refresh rate	≥ 1200Hz	≥ 1200Hz	≥ 1200Hz	≥ 1200Hz	≥ 1200Hz
平均功率 Average power	250W/m <sup>2</sup>	250W/m <sup>2</sup>	250W/m <sup>2</sup>	250W/m <sup>2</sup>	250W/m <sup>2</sup>
最大功率 Maximum power	800W/m <sup>2</sup>	800W/m <sup>2</sup>	800W/m <sup>2</sup>	800W/m <sup>2</sup>	800W/m <sup>2</sup>
屏体色温 Screen color temperature	2000K~9500K	2000K~9500K	2000K~9500K	2000K~9500K	2000K~9500K
水平/垂直视角 Viewing angle (H/V)	120° /120°	120° /120°	120° /120°	120° /120°	120° /120°
驱动方式 Drive mode	恒流驱动	恒流驱动	恒流驱动	恒流驱动	恒流驱动
工作电压 Operating voltage	AC: 105V~240V, 50~60Hz	AC: 105V~240V, 50~60Hz	AC: 105V~240V, 50~60Hz	AC: 105V~240V, 50~60Hz	AC: 105V~240V, 50~60Hz
防护等级 Protection class	正面IP65/背面IP43	正面IP65/背面IP43	正面IP65/背面IP43	正面IP65/背面IP43	正面IP65/背面IP43
工作温度范围 Operating temperature	-20° C~+50° C	-20° C~+50° C	-20° C~+50° C	-20° C~+50° C	-20° C~+50° C
工作湿度范围 Working humidity	10%~90%RH	10%~90%RH	10%~90%RH	10%~90%RH	10%~90%RH

# P系列 户外直插产品

P series outdoor DIP



## 应用范围:

大型全天候户内外综合娱乐广场、影院剧院、演艺背景屏、展会展示等应用领域。

## Application areas:

indoor and outdoor use, large scale squares, theaters, events, trade shows and so forth.

## 产品细节 Product details



户外直插式防水灯珠  
DIP

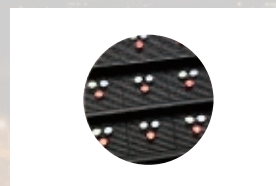

模块正面  
front

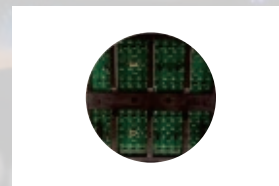

模块背面  
back



防水信号航插头  
water proof signal air plug

## 产品特点 Features

- ◆ 高亮度，最高可达10000cd/m<sup>2</sup>  
High brightness, up to 10000cd/m<sup>2</sup>
- ◆ 高防水性，高稳定性  
High waterproof property, high stability
- ◆ 广视域：宽视角设计，画面效果更优质，受众人群更广  
Wide viewing angle



高亮真彩  
high brightness and  
full color



广视域  
viewing angle



节能  
energy efficient



## 产品参数 Specifications

型号 mode	P10	P12	P16
像素间距 Pixel pitch (mm)	10	12	16
箱体尺寸 Cabinet size (mm)	960×960×145	960×960×145	1024×1024×145
箱体分辨率(px)	96×96	80×80	64×64
箱体重量 Cabinet weight (kg)	46	46	55
LED封装形式 LED configuration	LAMP346	LAMP346	LAMP346
亮度 Brightness	6500cd/ m <sup>2</sup>	6500cd/ m <sup>2</sup>	6500cd/ m <sup>2</sup>
刷新率 Refresh rate	≥1200Hz	≥1200Hz	≥1920Hz
平均功率 Average power	250W/m <sup>2</sup>	250W/m <sup>2</sup>	250W/m <sup>2</sup>
最大功率 Maximum power	800W/m <sup>2</sup>	800W/m <sup>2</sup>	800W/m <sup>2</sup>
屏体色温 Screen color temperature	2000K-9500K	2000K-9500K	2000K-9500K
水平/垂直视角 Viewing angle (H/V)	120° /120°	120° /120°	120° /120°
驱动方式 Drive mode	恒流驱动	恒流驱动	恒流驱动
工作电压 Operating voltage	AC: 105V~240V, 50~60Hz	AC: 105V~240V, 50~60Hz	AC: 105V~240V, 50~60Hz
防护等级 Protection class	IP41	IP41	IP41
工作温度范围 Operating temperature	-20° C~+50° C	-20° C~+50° C	-20° C~+50° C
工作湿度范围 Working humidity	10% ~ 90%RH	10% ~ 90%RH	10% ~ 90%RH



# 定制系列

Customize series

---

T系列 T Series

D系列 D Series



## 深圳机场

Shenzhen Airport

## 捷克体育馆球场屏

Czech Stadium

## 荷兰体育场球场屏

The Netherlands stadium

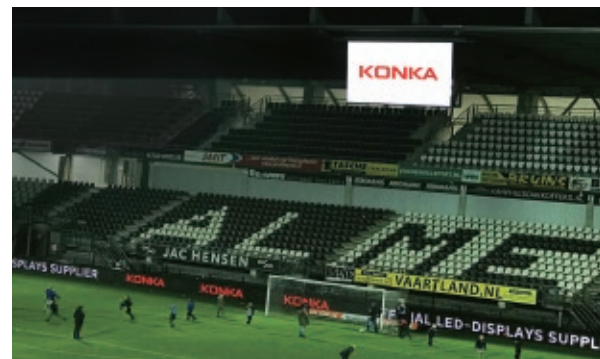
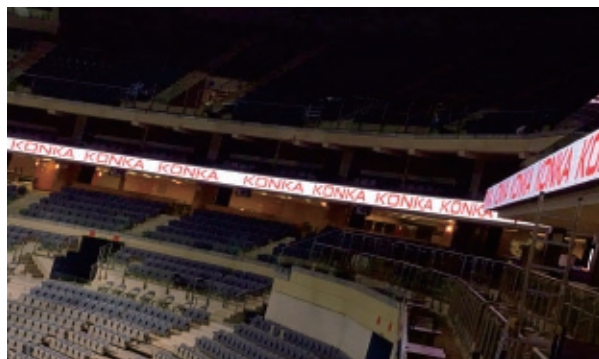

# 案例展示

# REFERENCE

# T系列 体育场馆产品

Tseries stadium screen

## 应用范围:

球场围栏广告、比分直播、  
球场比赛画面回放等

## Application areas:

Stadium fencing advertising,  
Live Scores, Replay of court  
match picture, etc.



## 产品细节 Product details

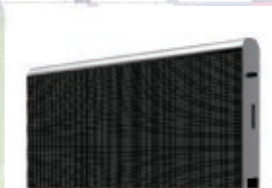

LED灯护顶设计  
Pins



可调角度  
no screws installation



简易拼接  
two layers water proof

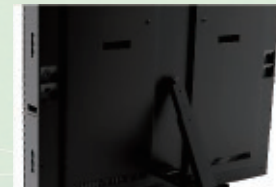

维护后盖  
no cables

## 产品特点 Features

- ◆ 全新结构设计，符合围栏、吊装、叠装三种安装方式要求，可进行多种场合的不同应用，能满足用户多种应用需求，且使用简单、方便；  
The new structure design meets the requirements of 3 kinds installation such as fencing, lifting and stacking, and can be used in many different applications.
- ◆ 可调节角度的后支撑架，用户可以任意调节显示屏的观看角度，以达到最佳显示效果；  
The rear stand with an adjustable angle can adjust the viewing angle of the display screen by User so as to achieve the best display effect.
- ◆ 拥有高达3840Hz的刷新频率，满足运动场上动态拍摄的需要，有效避免了拍摄时的闪烁现象；  
With up to 3840hz refresh frequency, it meets the needs of dynamic shooting on the sports field and effectively avoids flickering when shooting;
- ◆ 采用前/后维护设计，便于后期的维护保养；  
Front / Back Service Design, Easy for later maintenance
- ◆ LED视频控制系统及电源供电系统带有双备份系统，一旦发生故障，客户可以立即切换到备用系统；  
LED video control system and power supply system with double backup system, in case of failure, customers can immediately switch to standby system.
- ◆ 防水效果好，拥有IP65的防护等级，这样使得显示屏在雨天天气里能够为您继续工作；  
Waterproof , with IP65 protection level, so that the display in rainy weather can continue to work for you
- ◆ 顶部护顶设计，选用软面罩和上部覆盖柔软的材料，既能保护led灯又不会因运动员碰撞而造成明显伤害；  
Top Cover Design , Screen' s Surface made by Soft Mask and Upper Cover with Soft Material , to Protect LED Lamp and Avoid the damage by the collision of athletes



高亮度  
bright



高通透  
transparency



维护简单  
easy to maintain



高清  
high definition



电源双备份  
power supply  
dual backup



高散热  
optimized cooling

## 产品参数 Specifications

型号 mode	T8	T10	T12
像素间距 Pixel pitch	8 mm	10 mm	12mm
像素密度 Pixel density (Px/m <sup>2</sup> )	15625	10000	6944
箱体尺寸 Cabinet size (mm)	1024 × 1024	1280 × 960	1920 × 960
箱体分辨率 Cabinet resolution (px)	128 × 128	96 × 96	80 × 80
箱体重量 Cabinet weight (kg)	55kg	50kg	50kg
LED封装形式 LED configuration	SMD 3 in 1	SMD 3 in 1	SMD 3 in 1
亮度 Brightness	≥ 6000cd/ m <sup>2</sup>	≥ 6500cd/ m <sup>2</sup>	≥ 5500cd/ m <sup>2</sup>
屏体色温 Screen color temperature	3700K-9500K 可调	3700K-9500K 可调	3700K-9500K 可调
水平/垂直视角 Viewing angle (H/V)	140° /140°	140° /140°	140° /140°
驱动方式 Drive mode	恒流驱动	恒流驱动	恒流驱动
刷新率 Refresh rate	1920Hz	1920Hz	1920Hz
工作电压 Operating voltage	4.2V	4.2V	4.2V
最大功率 Maximum power	800W/m <sup>2</sup>	730W/m <sup>2</sup>	550W/m <sup>2</sup>
平均功率 Average power	240W/m <sup>2</sup>	240W/m <sup>2</sup>	180W/m <sup>2</sup>
防护等级 Protection class	IP65 /IP54	IP65 /IP54	IP65 /IP54
工作温度范围 Operating temperature	-20° C~+40° C	-20° C~+40° C	-20° C~+40° C
工作湿度范围 Working humidity	-30% ~ 60%	-30% ~ 60%	10% ~ 90%

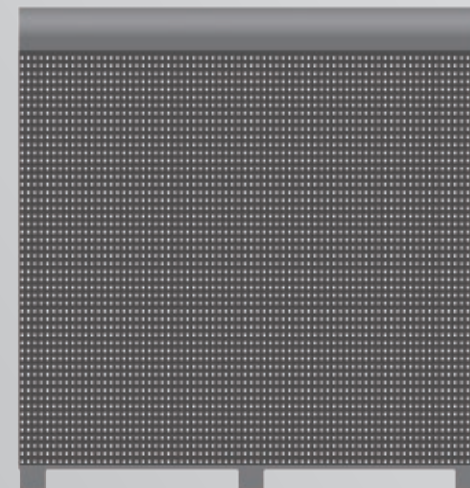

## ▶ D系列(定制屏)

数字标牌产品

D series Digital signage



### LED灯杆屏

Outdoor light pole  
fixed installation  
LED screen



### 应用范围:

综合商业广场、城市道路两旁

### Application areas:

Comprehensive commercial plaza,  
On both sides of the city road



### 海报屏

Poster LED screen

#### 应用范围：

综合商业广场、展会、商店

#### Application areas:

Comprehensive commercial  
plaz, Exhibition

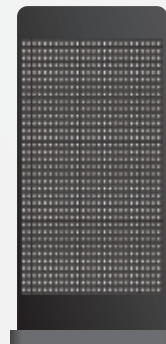

### 户内LED广告机

Indoor LED screen

#### 应用范围：

综合商业广场、机场等

#### Application areas:

Comprehensive commercial  
plaz, Airport

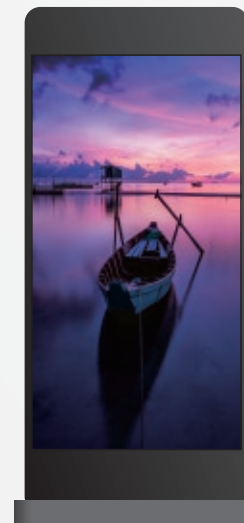



**KONKA 康佳**

康佳集团股份有限公司  
Konka group Co.,Ltd  
深圳市康佳壹视界商业显示有限公司  
Shenzhen Konka E-display Co.,Ltd

地址：深圳市南山区科技南12路28号康佳研发大厦22楼  
Add: KONKA R & D Building,High-tech Park, Nanshan,  
Shenzhen ,China, 518057

[www.konka-led.com](http://www.konka-led.com)(EN)  
[www.konkaled.cn](http://www.konkaled.cn)(中文)

Tel: +86-755-26608866-3998  
Fax: +86-755-61368816  
E-mail: [marketing@konka.com](mailto:marketing@konka.com)

全国服务热线：400-880-0016



**免责声明**

本资料仅供参考，画面均为参考画面，具体参数及功能请以所发出实物为准。  
本公司保留更改产品设计及规格的权利，届时恕不另行通知。如有疑问，请致电康佳集团客户服务热线。